

Handcrafted Leather Pulls and Handles

walnut
ORIGINAL MODERN DESIGNS
<https://walnutstudiolo.com>



Photo credit LocalPDX

Our Story

Sustainable Materials | Made in Oregon | Small Business



Founded in 2009 by architecture graduate Geoffrey Franklin, Walnut Studiolo crafts original modern designs by hand in our Oregon workshop using only natural materials. Trade discount and customization services available.

walnut

<https://walnutstudiolo.com>
valerie@walnutstudiolo.com
+1 503-447-6889

Also find us on:

Etsy

The Oswego Leather Wrap



A tactile and luxe leather handle wrap designed for kitchen appliances (& more) that matches our gorgeous leather handles & pulls

MATERIALS

- Hand-dyed American vegetable-tanned leather

walnut

ORIGINAL MODERN DESIGNS
<https://walnutstudiolo.com>

New in 2023, our Oswego wrap comes as a kit that can be installed on any shape handle.

The kit features:

- High-quality American leather that is durable in all the elements, warm to the touch, and has an outstanding handfeel
- Cleans easily and will develop a rich patina with age and use
- Will last a lifetime: can be un-installed and re-installed on new appliances and moved from house to house
- A staple extension system for connecting multiple wraps on extra-long handles (even bannisters!)
- An optional leather "cuff" for neatly-finished ends



The Burnside



A flexible hinge and an open loop make for easier grasping and perpendicular pulling.

MATERIALS

- Hand-dyed American vegetable-tanned leather
- Nickel, Brass or Black hardware

walnut

ORIGINAL MODERN DESIGNS
<https://walnutstudiolo.com>

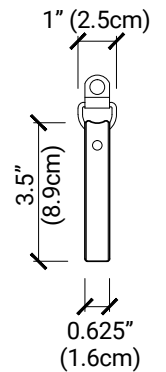
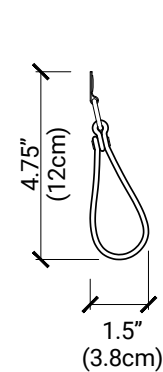
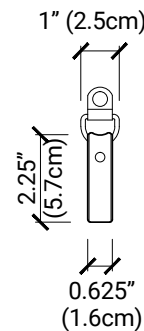
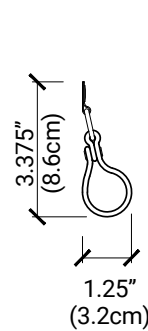
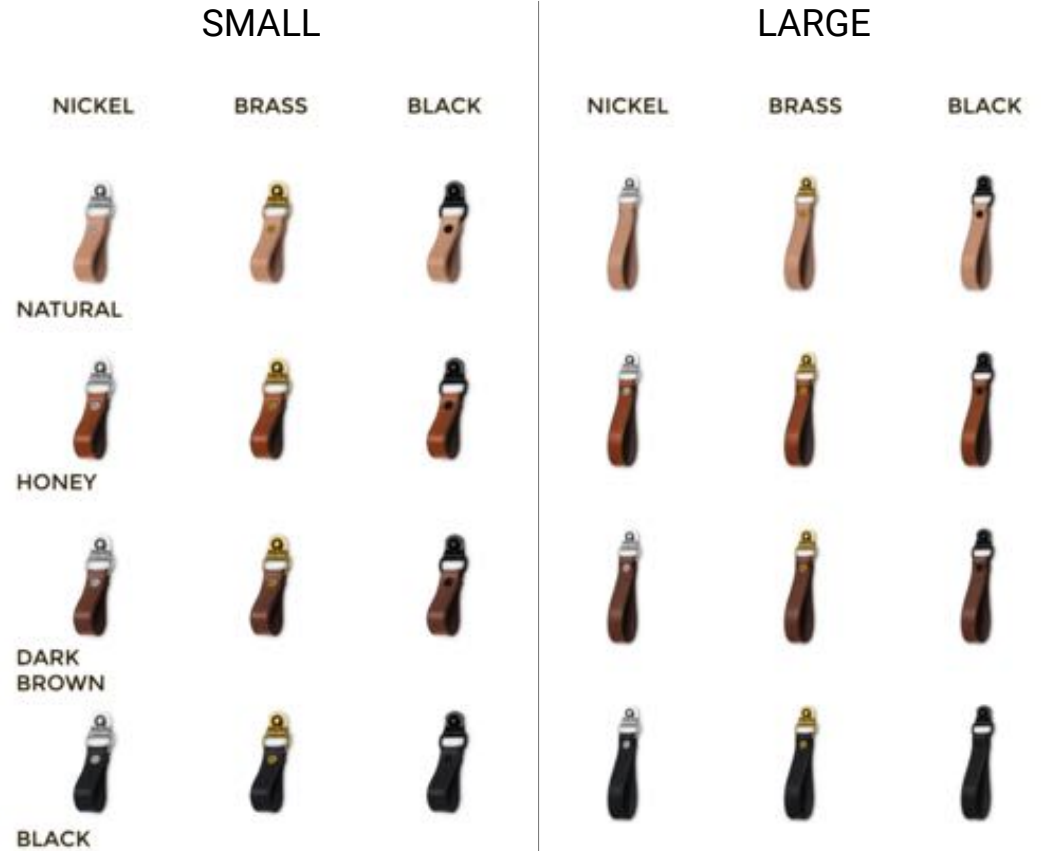
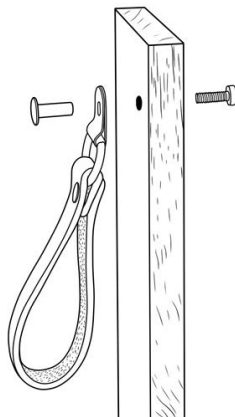

The Flanders



A classic leather handle with elegant minimalism. Two points of contact for a sturdy connection. Available in 3 sizes. Can be installed vertically or horizontally.

SIZES

- 3" Center-to-Center
- 3.5" Center-to-Center
- 4" Center-to-Center

MATERIALS

- Hand-dyed American full grain veg-tan leather
- Nickel, Brass or Black hardware

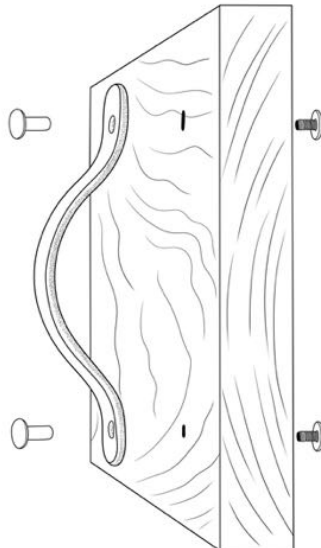

3" C2C

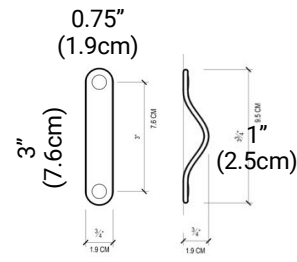

NICKEL



3.5" C2C

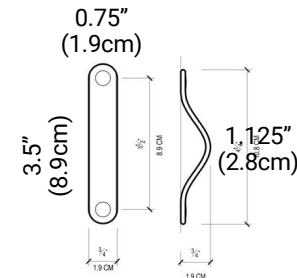

BRASS



NATURAL



HONEY



DARK BROWN



BLACK

4" C2C

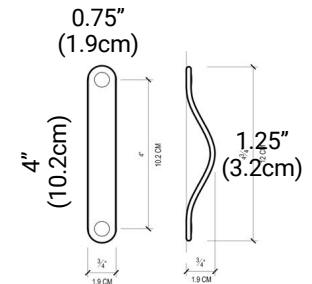

BLACK



walnut

ORIGINAL MODERN DESIGNS
<https://walnutstudiolo.com>

The Fremont



The Fremont is a horizontal basket pull perfect for reaching down to drawers. The same pull can also be folded into a vertical loop as the Hawthorne Wide.

MATERIALS

- Hand-dyed American vegetable-tanned leather
- Nickel, Brass, or Black hardware

walnut

ORIGINAL MODERN DESIGNS
<https://walnutstudiolo.com>

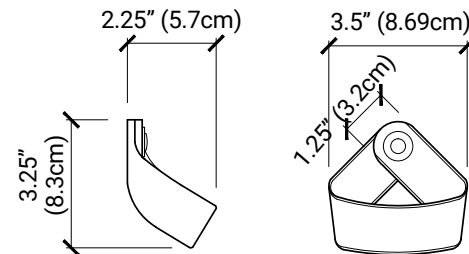
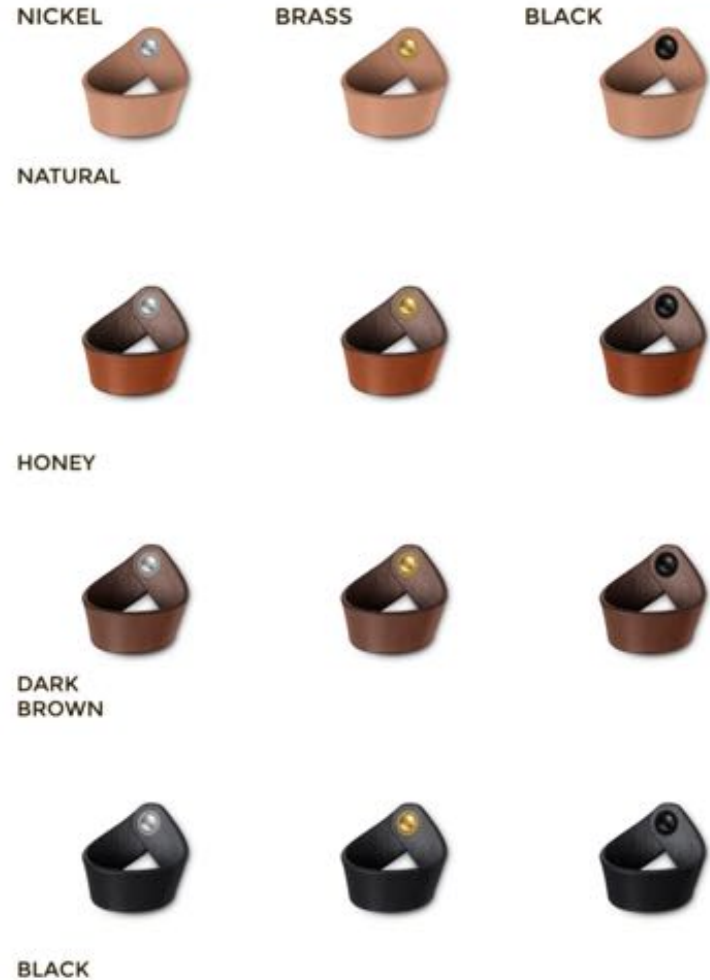
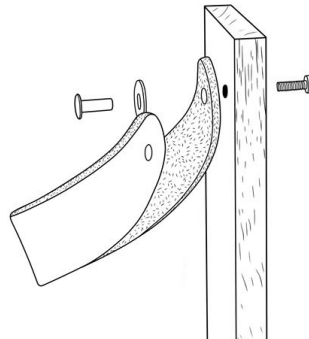

The Hawthorne



SMALL

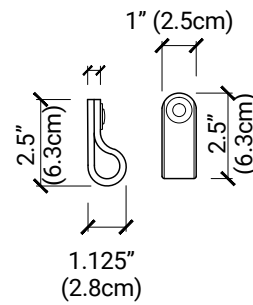

LARGE

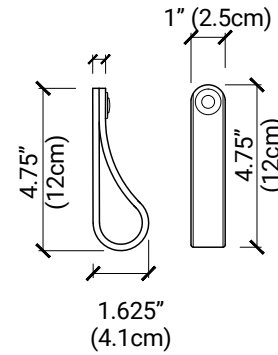

WIDE

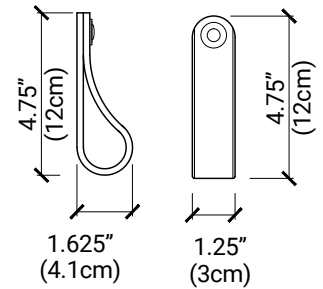

The Hawthorne is a classic loop-style pull perfect for reaching up to cabinets and drawers.

MATERIALS

- Hand-dyed American vegetable-tanned leather
- Nickel, Brass, or Black hardware



walnut

ORIGINAL MODERN DESIGNS
<https://walnutstudiolo.com>

The Lovejoy



The elegant profile of this all-leather cabinet handle performs a magic trick in industrial design, disappearing into the cabinetry for a beautifully integrated look.

MATERIALS

- Hand-dyed American full grain vegetable-tanned leather
- Nickel, Brass or Black hardware

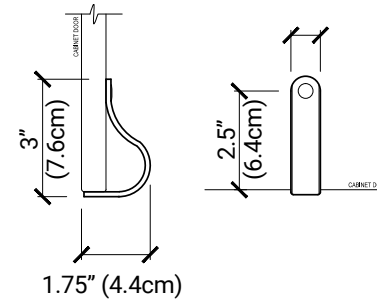
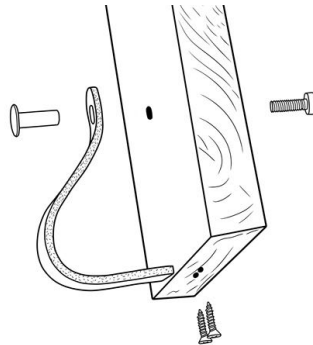

walnut

ORIGINAL MODERN DESIGNS
<https://walnutstudiolo.com>

The Morrison



The shape of our bin pull mimics the look of vintage metal bin pulls, but it's made with sturdy leather, warm to the touch and soft on impact.

MATERIALS

- Hand-dyed American vegetable-tanned leather
- Nickel, Brass, or Black hardware

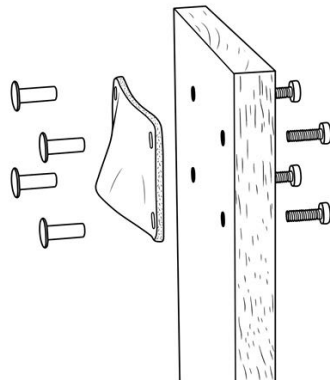

walnut

ORIGINAL MODERN DESIGNS
<https://walnutstudiolo.com>

NICKEL



BRASS



BLACK



NATURAL



HONEY



DARK BROWN



BLACK

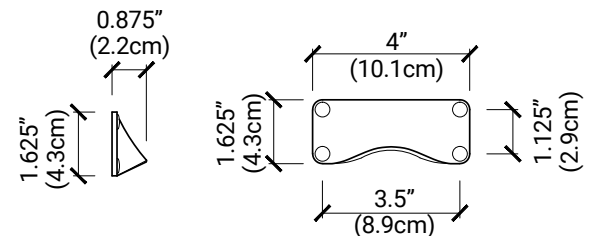

The Sellwood



Leather, meet Wood. This is a beautiful and versatile handle for long cabinets and drawers that can be mounted vertically or horizontally.

MATERIALS

- Hand-dyed American vegetable-tanned leather
- Finished American white oak wood
- Nickel, Brass, or Black hardware

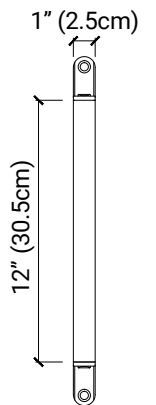
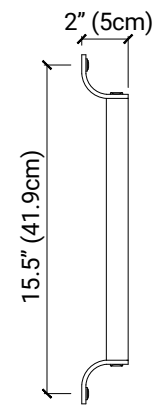
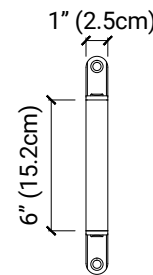
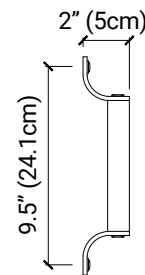
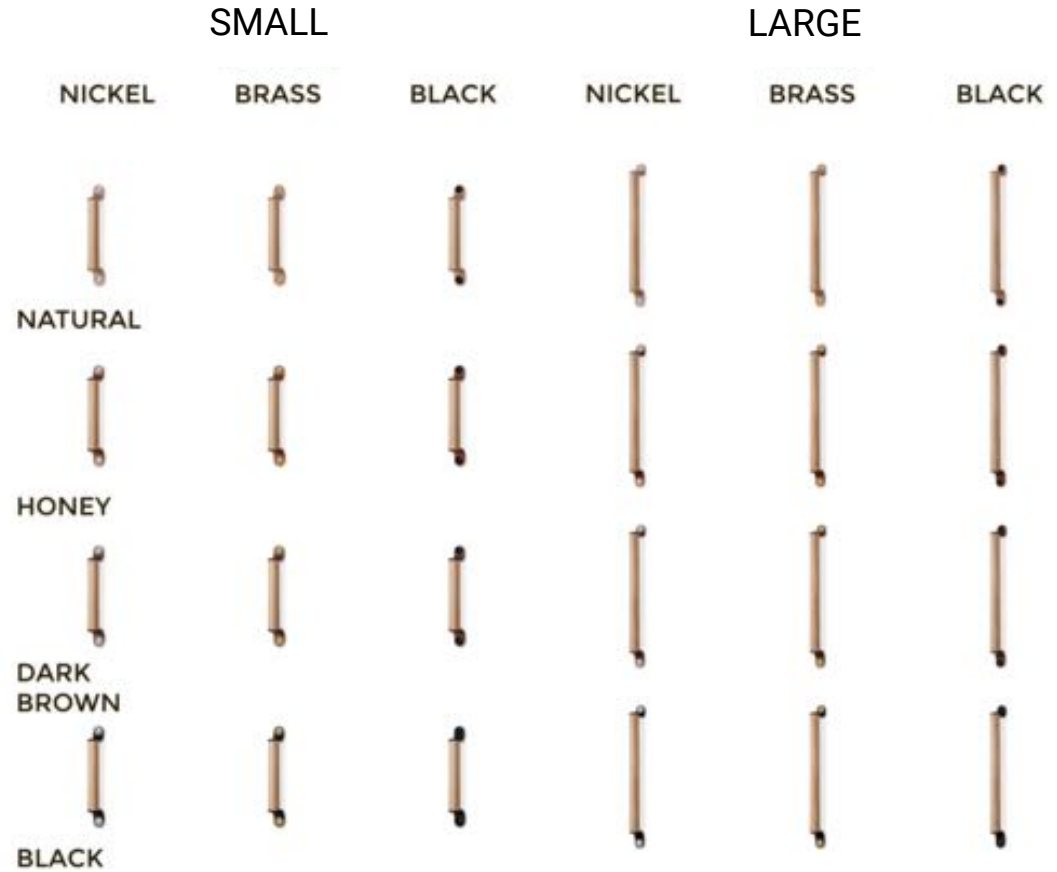
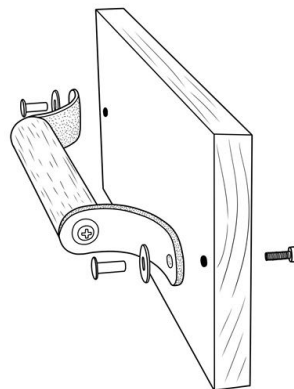

walnut

ORIGINAL MODERN DESIGNS
<https://walnutstudiolo.com>

The St. Johns



A small leather tab is perfect for lightweight doors and drawers and tight spaces. Can be installed in one-way applications with a wood screw.

MATERIALS

- Hand-dyed American vegetable-tanned leather
- Nickel, Brass or Black hardware
- No Hardware option for direct applications

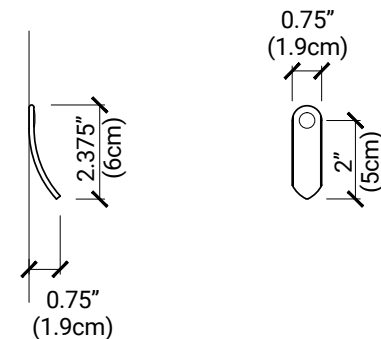
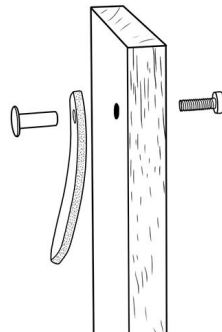

walnut

ORIGINAL MODERN DESIGNS
<https://walnutstudiolo.com>

The Tilikum

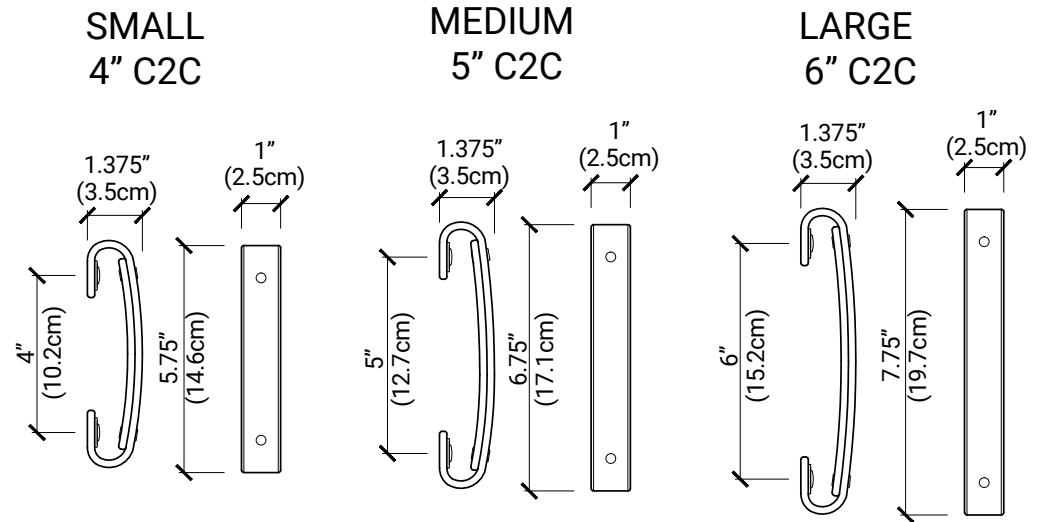

A traditional handle large enough to be a statement piece, vertically or horizontally. It has two points of contact for a strong anchor. Now in 3 sizes.

MATERIALS

- Hand-dyed American vegetable-tanned leather
- Nickel, Brass, or Black hardware

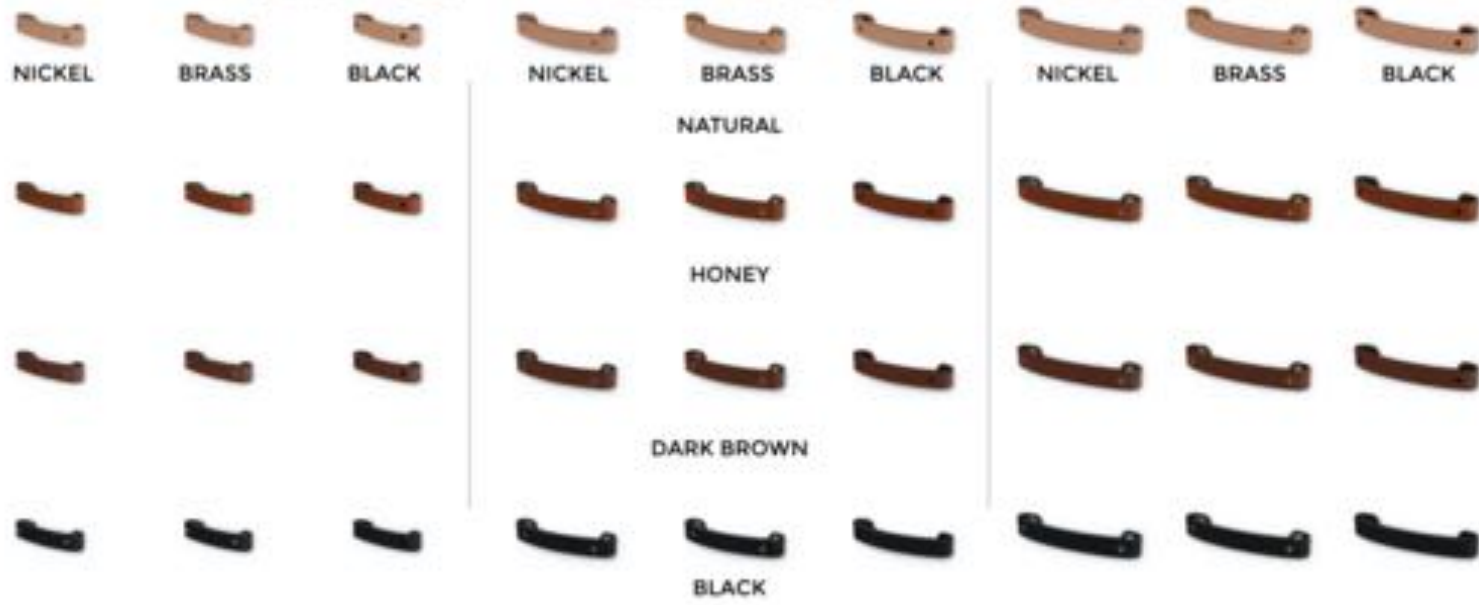

ORIGINAL MODERN DESIGNS
<https://walnutstudiolo.com>

Customization Services

Custom Logos & Brands | Custom Sizes | Monogramming & Labeling



Ask us how we can customize these handles for the perfect fit. In addition to custom sizing, we can personalize handles using brass stamp debossing, laser engraving, or an economical monogramming / labeling service using our two available alphabet sizes in two font styles.

walnut

<https://walnutstudiolo.com>

valerie@walnutstudiolo.com

+1 503-447-6889